

● **AW-HE100 Main Specifications**

Camera		
Image Elements	1/3-inch interline 3CCD (progressive compatible)	
Lens	Power 13x zoom, F1.6-2.8 (f=4.2 mm to 55 mm, 35 mm equivalent: 32.5 mm to 423 mm)	
Focus	Auto/Manual switchable	
Optical Color Separation	Prism system	
Gain Selection	0 dB to 12 dB in steps, 15 dB, 18 dB, AGC	
Shutter Speed	1/100, 1/250, 1/500, 1/1000, 1/2000, Syncro-scan (60.0 Hz to 248.8 Hz)	
Gamma	Low, mid, high	
White Balance	AWC A, AWC B, ATW, 3 200 K, 5 600 K	
Black Balance	Auto	
Variable Chroma Levels	7 levels	
Scene Files	Halogen light, fluorescent light, daylight, user	
Color Bar	SMPTE (SD) ,Full-Bar (HD)	
Output Format	1080/59.94i, 720/59.94p, 480/59.94i, 480/29.97psF	
Video Output*	Composite	1.0 Vp-p/75 Ω (BNC x 1)
	Y/C	Y: 1.0 Vp-p/75 Ω , C: 0.286 Vp-p/75 Ω (Burst) (VGA 15P x 1)
	Y/Pr/Pb**	Y: 1.0 Vp-p/75 Ω , Pr/Pb: 0.7 Vp-p/75 Ω (VGA 15P x 1)
Synchronization System	Internal/External synchronization, BBS or VBS	
Pan-tilt Mechanism		
Camera/pan-tilt head Control	Control cable	10BASE-T straight cable (UTP category 5), max. 1000 m (control only***)
	Protocol	RS-422 (Panasonic AW series protocol)
Rotation Speed	Over 60 °/s	
Rotation Range	Pan: over ±175 °, tilt: over +210 ° to -40 °	
Noise	NC35 (at 60 °/s in motion), NC30 (at 30 °/s in motion)	
Stop Accuracy	±3' (0.05 °)	
Operating Temperature	0 °C to +40 °C (32 °F to 104 °F)	
Storage Temperature	-20 °C to +50 °C (4 °F to 122 °F)	
Power	AC120 V	
Power Consumption	Approx. 40 W	
Dimensions (W x H x D)	216 mm x 332 mm x 257 mm (8-1/2 " x 13-1/16 " x 10-1/8 ") (excluding protrusions and mounting brackets)	
Weight	Approx. 7.0 kg (15.4 lbs) (without options and mounting brackets)	
Standard Accessories	Wireless remote control, power cable (for Japan & for North America 1 each), mounting bracket (for tabletop or ceiling), mounting bracket (for main unit), drop-prevention wire, cable cover, mounting screws, rubber feet (with mounting screws)	
Wireless Remote Functions	Select camera (1 to 4), switch camera power (on/standby), open camera menu, switch modes, set AWC/ABC, switch gain, switch options, call preset (1 to 12), set preset/limit, pan-tilt operation, back to home position, zoom operation, focus operation, iris operation, switch focus mode, switch iris mode, adjust speed (pan/tilt/zoom/focus/iris/call preset)	

* SETUP may be selected for composite or Y/C outputs only.
 ** With Y/Pr/Pb, the output format will change between 1080i/720p/SD(480i/480psF) depending on the format settings. With SD, you can select Y/Pr/Pb or Y/C from component setting.
 *** To extend video signal, you will need additional external equipment.

● **Dimensions**

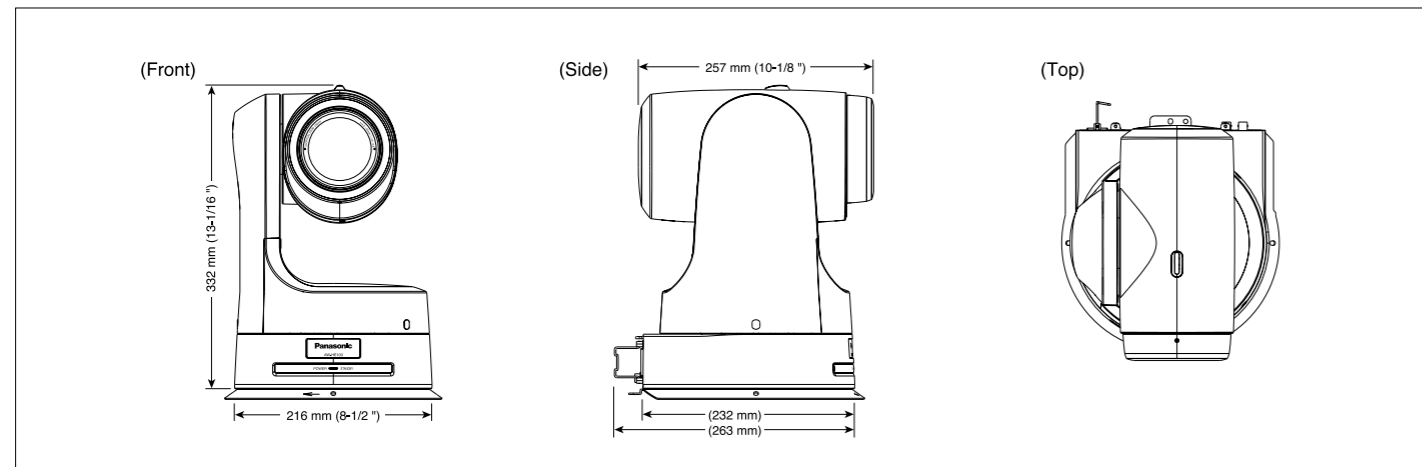

Panasonic

Panasonic Broadcast & Television Systems Co.
 Unit of Panasonic Corporation of North America
www.panasonic.com/broadcast

Government Sales: phone: 201-348- 7587
 Headquarters: 3 Panasonic Way, 4E-7, Secaucus, NJ 07094; phone: 201-348 -5300
 Eastern Zone: 3 Panasonic Way, 4E-7, Secaucus, NJ 07094; phone: 201-348 -7196
 Western Zone: 3330 Cahuenga Blvd. West, Los Angeles, CA 90068; phone: 323-436-3608

HD Integrated Camera with smooth pan-tilt moves and great picture quality



Shoot in HD and stand definition, with easy installation and smooth operation. Powerful, Integrated HD/SD Camera ideal for a wide range of venues and applications.



Smart integrated design and high performance rotation pan-tilt head

Delivers highly-accurate remote image capture with fast, precise, ultra-smooth pan-tilt system and a wide range of movement.



Production quality 3CCD system & 19-bit Digital Signal Processing (DSP)

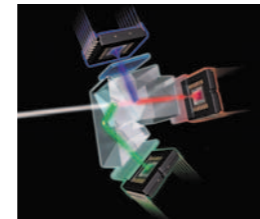

Equipped with Panasonic's exclusive high-precision 1/3-inch 3CCD and 14-bit A/D Converter & 19-bit Digital Signal Processing (DSP), the AW-HE100 shoots crisp, high resolution, high definition images.

A fast, versatile 13x High Definition zoom lens delivers great images

Superior video can be produced in a wide range of shooting conditions, thanks to the camera's HD zoom lens with a F1.6 aperture and a 32.5 mm (35 mm equivalent) minimum focal length.



HD Integrated Camera AW-HE100

- Offers HD/SD formats with the ability to switch between 1080i, 720p, 480i, and 480psF.
- The camera's stylish design blends in with a wide range of colors and decor.
- Standard accessories include a wireless remote for control of up to four cameras. Wired RS-422 control is also supported.



Halls/legislative halls

Delivers precise and intuitive camerawork in combination with a high performance control panel. Offers effective operation depending on the application or scale, from broadcasting high definition images on large displays in the venue to coverage of seats in the legislative halls using the preset memory function.



Business setting

Easy installation even on ceilings or tabletops. Conduct high resolution, live TV conferencing readily by using the cameras in combination with a live switcher.



Studio production

One-man remote operation of multiple AW-HE100 units is possible, so less space is required for camera tripods and for camera operators to move around in. As well as saving space, this contributes to more efficient shooting in the studio.



School and other educational applications

A wireless remote control provided as standard gives you command over up to four cameras. Even without specialist knowledge, virtually anyone can easily operate the cameras and pan/tilt heads.



Indoor sports facilities

Providing 60 °/sec high-speed pan and tilt, the AW-HE100 lets you precisely catch even rapidly moving subjects. Add to this wide pan/tilt range enabling shooting from various angles, and you have the ideal camera for recording in gymnasiums, skating rinks and other sports facilities.



High resolution monitoring

The smart and compact integrated design of the AW-HE100 will naturally blend in with any surrounding. Useful for monitoring in high resolution.

Please refer to p.6-7 for details concerning system configuration examples.

Integrated camera with a smart design offering high resolution and smooth movement.



High resolution, high definition shooting

Compatible with four (HD/SD) video formats

Using the menu screen lets you easily switch between the 1080i, 720p, 480i and 480psF formats. What's more, simultaneous HD and SD output enables smooth transition from an SD to an HD environment.

Compatible formats

HD 1080/59.94i, 720/59.94p

SD 480/59.94i, 480/29.97psF

Highly sensitive progressive 3CCD, excellent for shooting indoors

Delivers highly sensitivity, high S/N, and high resolution by employing a wide light collecting surface of 1/3-inch CCD.



Reproduces a bright and crisp image even indoors.

High definition, 13x zoom lens with auto and remote focus

An 13x, HD zoom lens with a fast F1.6 maximum aperture provides both manual/remote and accurate autofocus capabilities.



Integrated zoom lens developed for HD

14-bit A/D Converter & 19-bit Digital Signal Processing (DSP)

Equipped with the same Panasonic exclusive high-precision Digital Signal Processing (DSP) found in our high-end broadcast cameras, the AW-HE100 delivers rich, vibrant video quality (i.e. gamma correction).



Delivers beautiful, low noise images



Broad range/high speed/precise rotation movement

Wide-area pan-tilt and Smart Flip function provide versatile coverage

The AW-HE100 provides a wide range of motion, with a pan range of $\pm 175^\circ$ and a tilt range from $+210^\circ$ to -40° . The camera also includes a versatile, use selectable Smart Flip function to automatically reverse the vertical orientation of the picture to provide natural looking video, even when the subject passes directly under the camera.

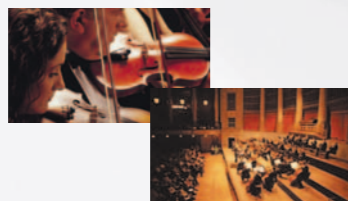

Shoot from precise angles with broad range rotation movement

High speed, accurate movement unfalteringly captures the dynamism of sports

Has both high speed motion of 60 °/s and pan-tilt stop accuracy of $\pm 3'$ (0.05 °). The camera accurately tracks high speed sports such as swimming and skating.

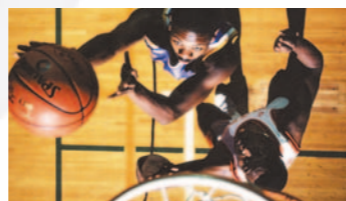

Unfalteringly shoots the intensive motion of sports

Shoot without disrupting the ambience with the silence of NC30

Operation is extremely quiet, with a noise level of just NC 30 (during 30 °/s operation), which is about as quiet as a library. This lets you achieve natural shooting results at weddings and in theaters and other locations where mood and atmosphere play an important role.



Shoot while preserving the natural ambience

A rich preset memory offering up to 100 positions

Various camera and lens position may be preset and memorized for easy recall. This is useful in situations where many fixed shots are required, and where non-technical personnel may need to operate the cameras.

* The number of preset memory positions will differ depending on the controller.



Easily switch between many positions



Easy installation/comfortable operation

A stylish body compatible for installation on ceilings and tabletops

Integrated smart design (pan-tilt, zoom lens, and camera), for simple cabling and installation on ceilings or walls.



Easy installation on ceilings and desktops

Wireless remote control supplied as standard

A full-featured wireless remote for control of up to four cameras is included as a standard accessory. The AW-HE100 is also compatible with current Panasonic RS-422 wired remote control systems. Easy operation and adjustment.



Range approximately 10 m (with no obstructions). However, the distance may become shorter if direct sunlight, light from a fluorescent lamp or light from a plasma display falls on the AW-HE100 main unit's IR receptor.

Operate multiple cameras at once. Supports system architecture built using existent equipment.

Other Peripherals



(Rear View)

Compact Size Controller AW-RP555*

Compact body offering full camera control.

Controls up to five cameras and rotation pan-tilt head. Fully control set up and picture quality using the camera menu. Set positions appropriate for each setting as each camera comes with up to 10 preset memory positions.

● Power Supply AW-PS510A is required.

Power supply	DC12 V
Power consumption	Approx. 9.0 W
Dimensions(W x H x D)	210 mm x 58 mm x 177 mm (8-1/4 " x 2-5/16 " x 7 ")
Weight	Approx. 1.4 kg (3.08 lbs)
Accessories	Rack mounting adapters(5U) x 2, Mounting screws(M4 x 8 mm) x 4



(Rear View)

Multi-function Controller AW-RP655*

Delivers highly sensitive pan-tilt movement and full camera control.

Controls up to five cameras and rotation pan-tilt head. Using the camera menu lets you control settings and picture quality. There's also preset memory for up to 50 positions for each camera, plus 10 tracing memories with a total memory time of 300 seconds. Up to two additional controllers can be connected to enable operation from multiple control rooms.

● Power Supply AW-PS510A is required.

Power supply	DC12 V
Power consumption	Approx. 9.0 W
Dimensions(W x H x D)	420 mm x 52 mm x 220 mm (16-1/2 " x 2-1/16 " x 8-11/16 ")
Weight	Approx. 3.5 kg (7.7 lbs)
Accessories	Rack mounting adapters(5U) x 2, Mounting screws(M4 x 8 mm) x 4



(Rear View)

Pan-tilt Controller AW-RP400

Ready for full-scale video production applications.

Enables precise control of up to five cameras with intuitive joystick/see-saw operation. You can also connect it to an AW-CB400 remote operation panel for controlling cameras.

● A protocol converter AW-IF400 and Power Supply AW-PS510A are required to use this unit.
● Tracing memory function does not work for the AW-HE100.

Power supply	DC12 V
Power consumption	Approx. 13.0 W
Dimensions(W x H x D)	320 mm x 85 mm x 266 mm (12-5/8 " x 3-3/8 " x 10-1/2 ")
Weight	Approx. 3.8 kg (8.4 lbs)
Accessories	Zoom switch x 1, Plug(D-SUB 15 pin)for tally/INCOM system x 1 set, Rack-mounting adapters x 2, Mounting screws(M4 x 8 mm) x 4

Remote Operation Panel AW-CB400*

Enables full control of up to five cameras.

Tally/Intercom functions. Providing full camera control, this compact unit boasts the maneuverability to enable use at a wide range of venues.

● Power is supplied by the AW-RP400.

Power supply	DC12 V
Power consumption	Approx. 3.8 W
Dimensions(W x H x D)	100 mm x 85 mm x 266 mm (4 " x 3-3/8 " x 10-7/16 ")
Weight	Approx. 1.4 kg (3.08 lbs)
Accessories	Pan-tilt controller(AW-RP400) connection cable(10 m)

Protocol Converter AW-IF400

Using an AW-RP400 enables operation of AW-HE100 pan-tilt head units (Maximum range of operation: 1 500 m)

● Power Supply AW-PS510A is required.

Power supply	DC12 V
Power consumption	Approx. 1.5 W
Dimensions(W x H x D)	145 mm x 30 mm x 85 mm (5-11/16 " x 1-3/16 " x 3-3/8 ")
Weight	Approx. 0.4 kg (0.88 lbs)

Feature Cards



SDI Outputs AW-HHD100

Add two HD/SD-SDI outputs by placing mounts in the expansion slot of the AW-HE100. ● Go to the main unit's menu to switch between SD/HD.

Dimensions(W x H x D)	159 mm x 27 mm x 111 mm (6-5/16 " x 1-1/16 " x 4-3/8 ")
Weight	Approx. 0.23 kg (0.51 lbs)

Power Supply AW-PS510A

Supplies electricity to control panels and live switchers.



Power supply	AC100 V to 120 V/1.4 A
Power output	DC12 V/5 A
Dimensions(W x H x D)	132 mm x 47 mm x 275 mm (5-1/4 " x 1-7/8 " x 10-7/8 ")
Weight	Approx. 1.6 kg (3.6 lbs)
Accessories	DC cable with 4-pin round connector: Approx. 2 m (6.6 ft.) DC cable with ϕ 5.5 plug: Approx. 3 m (9.9 ft.) DC cable with ϕ 6.5 plug: Approx. 3 m (9.9 ft.) Power plug conversion adapter (for Japan)

* Models manufactured before March 2008 require upgrading. For details, please contact a sales outlet.

Ready for applications ranging from a simple system using the supplied remote control to a large-scale system.

Simple system ①

Taking advantage of the AW-HE100's ability to simultaneously output HD and SD video signals, when shooting at event venues you can provide live coverage with HD quality images at the venue while making an SD quality recording.

- HD Integrated Camera AW-HE100 1
- HD Projector or PDP 1
- SD Recorder or DVD Recorder 1

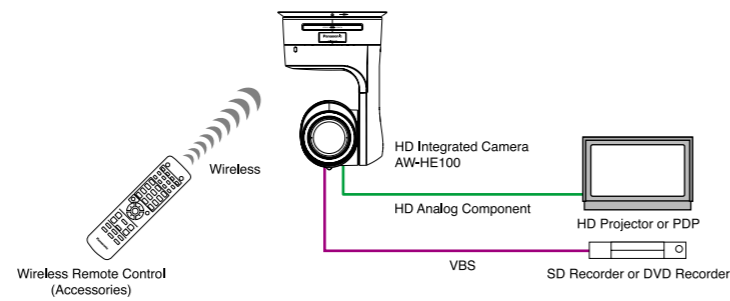
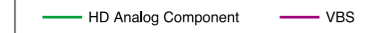

Simple system ②

Using multiple AW-HE100 units lets you shoot and record in both HD and SD quality. You can also shoot from various angles to match the subject being recording.

- HD Integrated Camera AW-HE100 5
- SDI Outputs AW-HHD100 5
- Pan-tilt Control Panel AW-RP555 1
- Multi-Format Live Switcher AV-HS300 1
- Power Supply AW-PS510A 2
- HD/SD Monitor 1
- HD/SD Recorder 1

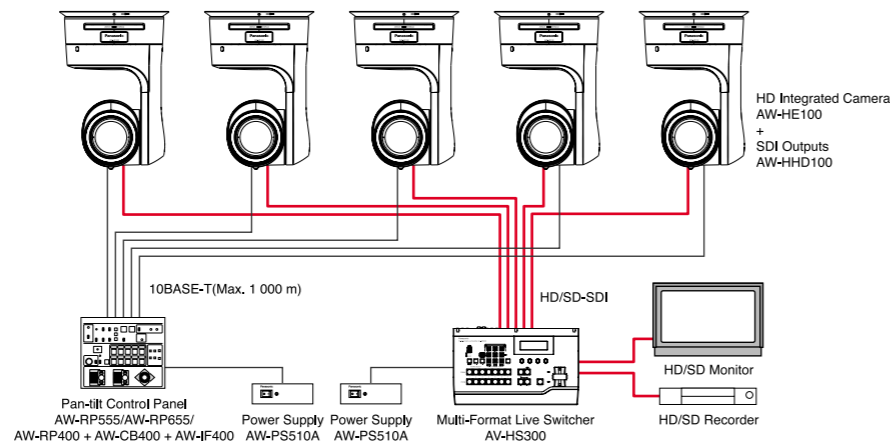
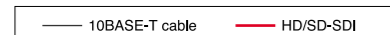

Mixed HD/SD system

A mixed HD/SD system can be created that incorporates AW-HE100 units used mostly for short-range shots, and convertible cameras for mid- to long-range shots.

- HD Integrated Camera AW-HE100 3
- SDI Outputs AW-HHD100 3
- 3CCD Convertible Camera AW-E860 2
- 20x MD Zoom Lens AW-LZ17MD9A 2
- Indoor Pan-tilt Head AW-PH360 2
- Power Supply AW-PH300A 2
- Pan-tilt Control Panel AW-RP555 1
- Power Supply AW-PS510A 1
- Multi-Format Live Switcher AV-HS400 1
- Analog inputs AV-HS04M2 1
- HD Monitor 1
- HD Recorder 1

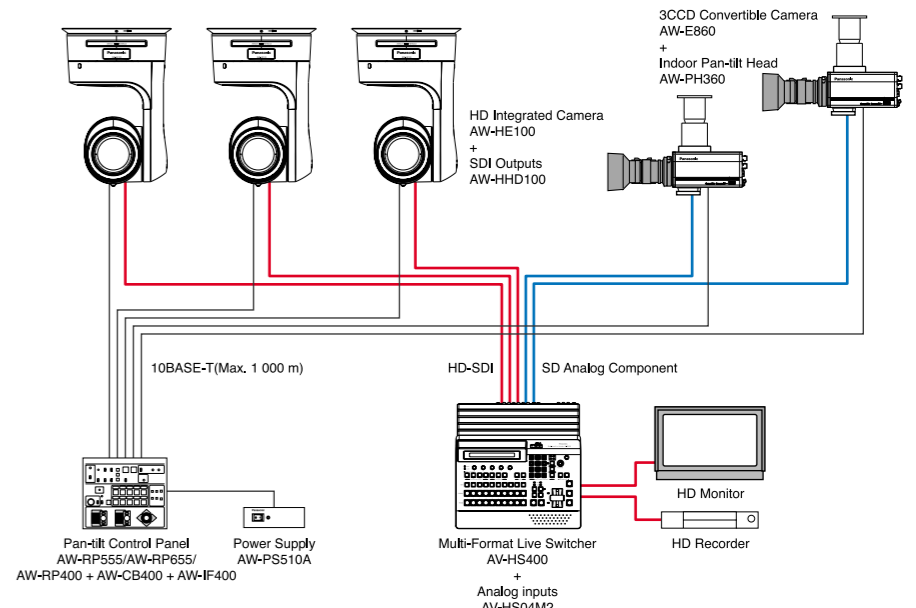
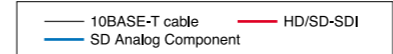

HD camera system

You can also enjoy coordinated operation from multiple control rooms. And when used with controllers providing preset memory for a maximum of 50 positions* for each camera, AW-HE100 units are ideal for shooting in conference halls and other large venues.

- HD Integrated Camera AW-HE100 3
- SDI Outputs AW-HHD100 3
- Multi-Purpose HD Box Camera AK-HC1500 2
- 20x HD Zoom Lens AK-LZ20M85 2
- Pan-tilt Control Cable AW-CA15H29 2
- Indoor Pan-tilt Head AW-PH405 2
- Multi-function Controller AW-RP655 3
- Multi-Format Live Switcher AV-HS300 1
- Power Supply AW-PS510A 4
- HD Monitor 1
- HD Recorder 1

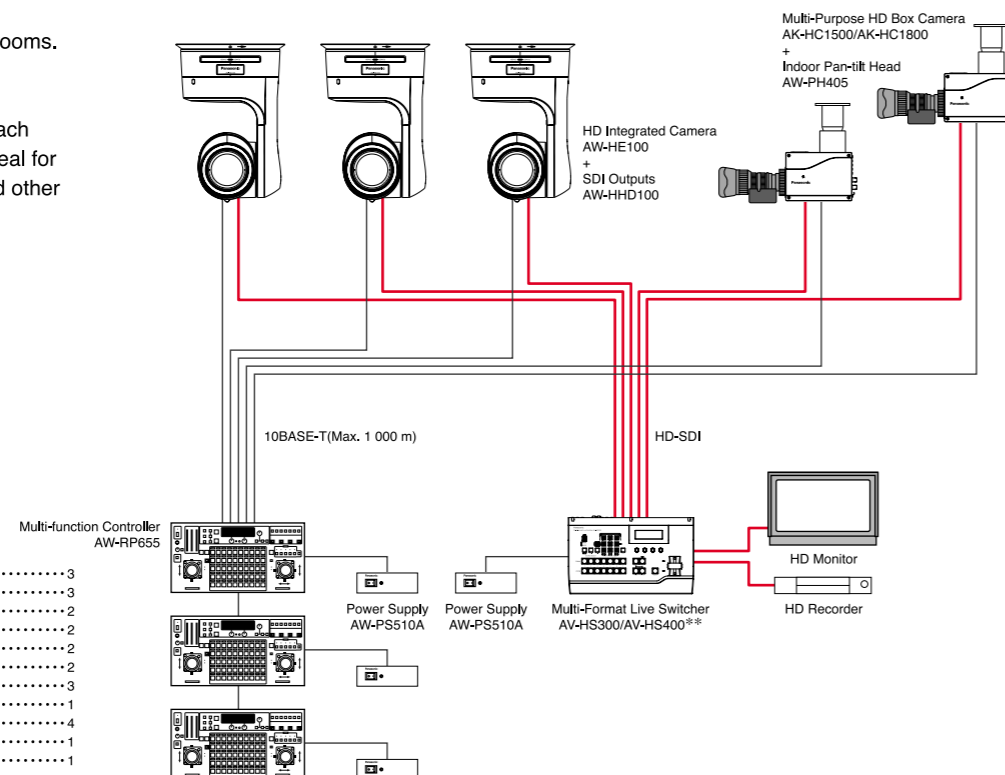
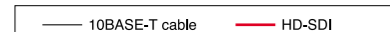

* The number of preset memory positions will differ depending on the controller.
** Use together with the AV-HS04M1 if you use the AV-HS400. The AV-HS400 does not require the AW-PS510A.

Rear View of the AW-HE100

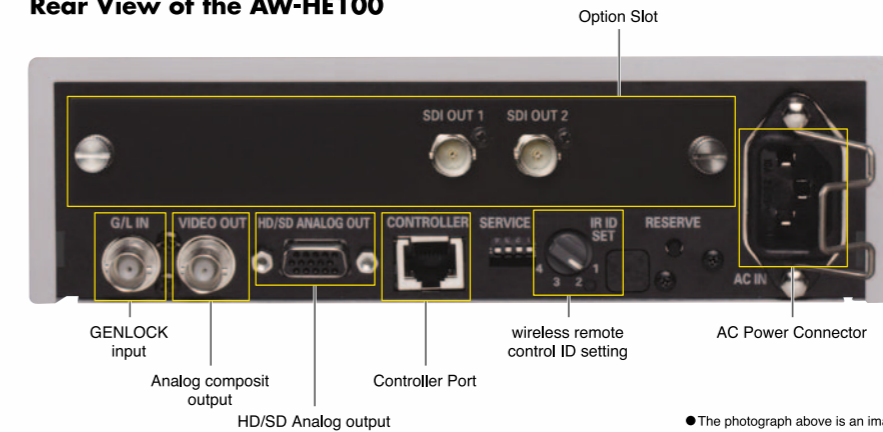

● The photograph above is an image with the SDI Outputs AW-HHD100 added.

Optimal for both hanging and desktop installation

The AW-HE100 comes standardly equipped with mounting brackets and a drop-prevention wire necessary for installation on ceilings.

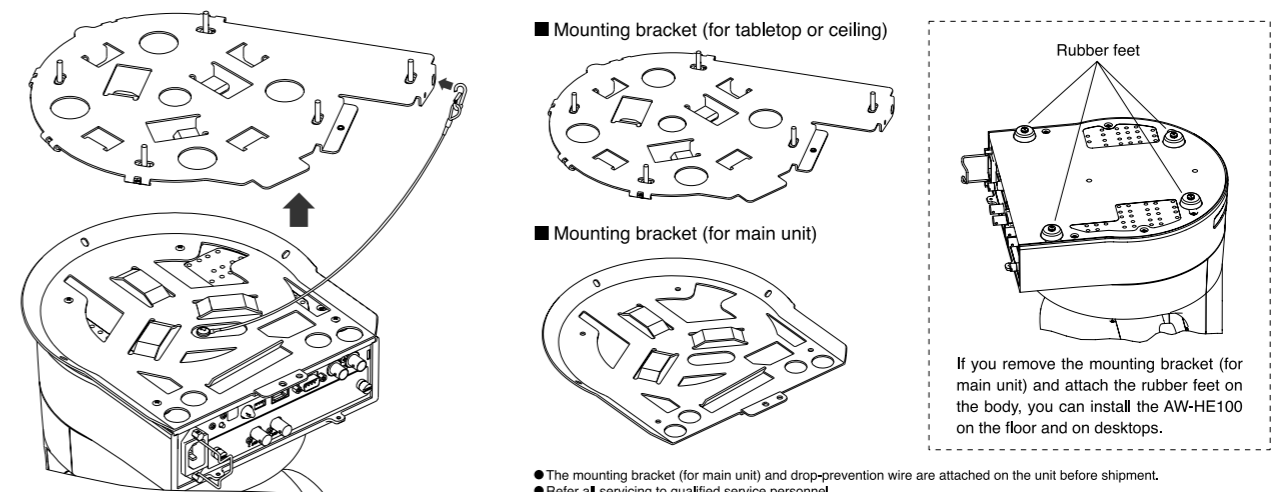

■ Mounting bracket (for tabletop or ceiling)

■ Mounting bracket (for main unit)

Rubber feet

If you remove the mounting bracket (for main unit) and attach the rubber feet on the body, you can install the AW-HE100 on the floor and on desktops.

● The mounting bracket (for main unit) and drop-prevention wire are attached on the unit before shipment.
● Refer all servicing to qualified service personnel.